

3M™ Water Filtration Systems for Commercial Foodservices



Recipe
Quality

Water™

3M

Product – History

Expert in Water Filtration Technology for 100 years!



CUNO Incorporated, a 3M company, is a world leader in the design and manufacturing of a comprehensive line of filtration products for separation, clarification and purification of fluids and gasses. It was set up in 1912 and began as a supplier of mechanical parts to the automobile industry and, at the same time, developed metal and mechanical filters.

During the 1960's it turned its attention solely to filtration and developed a line of resin bonded depth filters for the industrial market that are still in production today. Progressing towards finer and more sophisticated filtration, CUNO's engineers invented a cellulose based filter that was charge modified, permitting the filtration of sub-micron particles. Variations of this filter are still used today in the blood fractionation and biopharmaceutical industries. CUNO was also a pioneer in the development of microporous membranes, and the use of nylon 66 for the formation of filtration membrane. Finally, leveraging the technology developed for the industrial market over to the residential and commercial drinking water market, the Company launched a full line of products under the "Aqua-Pure" brand name. CUNO's unique carbon block process results in a product that reduces a wide variety of chemical contaminants in water while delivering high flow rates and low pressure drop.

In 2005, CUNO was acquired by 3M to combine the innovation of 3M with the filtration application know-how of CUNO. The combined entity participates in virtually all the key markets for liquid filtration. In 2009, CUNO Incorporated officially changed its name to 3M Purification Inc.

Located in Connecticut, the USA, the manufacturing plant of water filtration products has been certified to NSF standards to maintain the quality management and ensure every filter produced is of the highest standard.

Product – Product Intro

Is it necessary to use water filters in Food & Beverage business?

Water filter systems have been widely used in food factories and restaurants around the world. In the U.S., commercial kitchens are legally required to use water filters. With the customers in Hong Kong becoming more and more conscious of the hygiene in restaurants, it is high time that the catering industry started considering serving their customers with filtered water, especially when it comes to preparing coffee, tea, fresh juices and ice-cream. It is because filtered water can bring out the best flavor of your food and drinks.

3M BEV Series, the Newest Models for F&B

The 3M™ BEV Series is using the revolutionary **IMPACTechnology media (Integrated Membrane Pre-Activated Carbon Technology)** for unsurpassed cartridge life and economy. A single 3M BEV filter can accomplish what was previously the job of a two- or three-cartridge system. The IMPACTechnology media package combines a patented pharmaceutical-grade micro-porous membrane and a patented pre-activated carbon block in a single cartridge to dramatically reduce pressure drop and eliminate the need for pre-filtration. The BEV Series water filters are also equipped with Sanitary Quick Change (SQC) technology for quick cartridge change-outs with a turn of the wrist.



While 3M BEV Series Water Filters effectively reduce odor, chlorine, particles, lead and cyst in water, complying with the NSF/ANSI Standard 42 and 53, they still retain the essential minerals in water. Hence the refreshing, great tasting water you get from our 3M water filters. To search for the NSF listing, please visit this website www.nsf.org/certified/consumer/listings_main.asp.



The followings are some of the restaurants and canteens using our 3M BEV Series Water Filtration Systems:

<u>Hong Kong</u>	<u>Macau</u>
A1 Bakery (3 stores)	Morton's, The Steakhouse
Burger King (15 stores)	Food Court in The Venetian-Resort-Hotel
Hang Seng Bank Staff Canteen, Mega Box	
Hong Kong Sanatorium & Hospital (3 canteens)	
Inagiku (Japanese Restaurant, 2 stores)	
Maxim's MX (10 stores)	
Press Room Group (4 stores)	
Sen-ryo (Japanese Restaurant, 6 stores)	
Watami Japanese Casual Restaurant (17 stores)	

3M BEV Series Water Filters - Specifications

Model	Capacity	Micron Rating	Flow (lpm)	Reduction Claims				Filter Head		Cartridge Model
				Chlorine, Taste & Odor	Sediment	Cyst	Bacteria	Model	Connections	
BEV120	34,069 liters (9,000 gallons)	0.5	5.7	•	•	•		VH3-BSP	3/8"	HF20
BEV125	37,854 liters (10,000 gallons)	1	5.7	•	•			VH3-BSP	3/8"	HF25
BEV130	52,996 liters (14,000 gallons)	0.5	6.3	•	•	•		VH3-BSP	3/8"	HF30
BEV135	47,696 liters (12,600 gallons)	1.0	6.3	•	•			VH3-BSP	3/8"	HF35
BEV140	94,635 liters (25,000 gallons)	0.2	7.9	•	•	•	•	VH3-BSP	3/8"	HF40
BEV145	94,635 liters (25,000 gallons)	3.0	7.9	•	•			VH3-BSP	3/8"	HF45
BEV160	132,489 liters (35,000 gallons)	0.2	12.6	•	•	•	•	NH3-B3P	1/2"	HF60
BEV165	132,489 liters (35,000 gallons)	3.0	12.6	•	•			NH3-BSP	1/2"	HF65
BEV190	204,412 liters (54,000 gallons)	0.2	18.9	•	•	•	•	NH3-B3P	1/2"	HF90
BEV195	204,412 liters (54,000 gallons)	3.0	18.9	•	•			NH3-B3P	1/2"	HF95

1. BEV120, BEV130, BEV140, BEV160 and BEV190 comply with both NSF/ANSI Standard 42 and Standard 53, while BEV125, BEV135, BEV145, BEV165 and BEV195 comply with NSF/ANSI Standard 42 only.
2. IMPACTechnology with nylon membrane applies to BEV140, BEV160 and BEV190 only.
3. The operation temperature and pressure of BEV series are 38°C and 125psi (862kPa) respectively.
4. It is recommended that the filter cartridges be replaced every 6 months in order for the products to deliver the best performance. However, the performance may vary depending on the water usage and quality. The cartridge should be changed once the flow of water slows down.
5. Do not use with water that is microbiologically unsafe or of unknown quality without adequate disinfection.

Other 3M Water Filters for Catering Industry

3M offers a complete line of filtration and treatment systems in order to provide clean, fresh tasting beverage water and maintain the efficiency and life span of your valuable equipment.



- SF18-S inhibits scale build-up and corrosion in high-temperature foodservice equipment, including coffee brewers, broiler-based steamers, proofers, ware-washers and hot tea machines.

- CFS8812X utilizes premium, activated carbon in a compressed format for ultra-fine filtration to 0.5 micron and cyst reduction to NSF standards. It exhibits low initial and operation pressure drop, extending the service life of cartridge.

Applications

Filtered Water Applications

With 3M™ water filtration system, the filtered water carries no contaminants while retaining essential minerals that can bring out the best flavor of your food and drinks, especially when it comes to preparing coffee, tea, fresh juice, rice, soup and fresh produce etc.

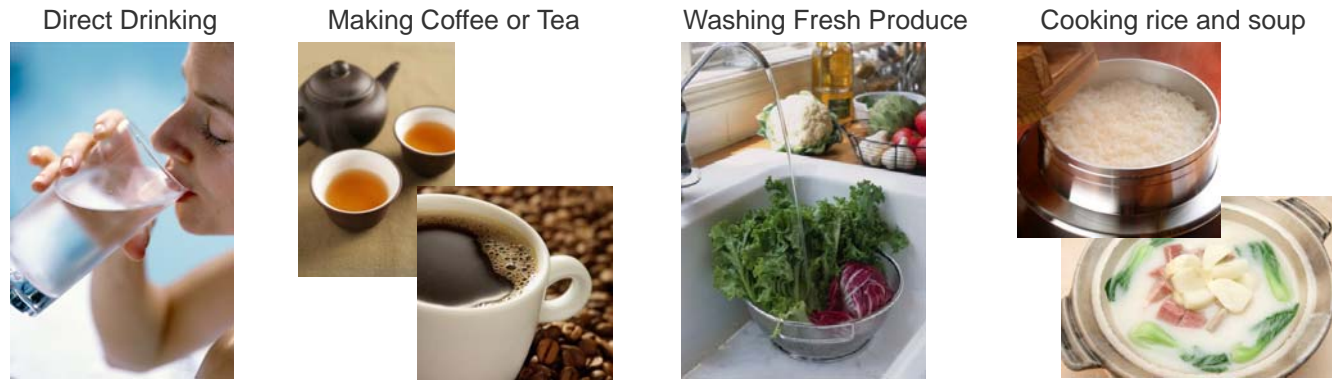

However, how to design a suitable filtration system for use?

For Office / Pantry

Compared with using bottle water station in the office or any outlet with pantry, **filtered water with hot & cold water station** can save you a lot more in storage space and cost. Here are some reference guides on the combination of water filtration system and relevant equipment. *(Please refer to the specification of each filtration system for matching with different kinds of equipment.)*

For an office with or a pantry catering for **15-20 people**,
1 unit of hot&cold water station with 3M BEV120 should be used.

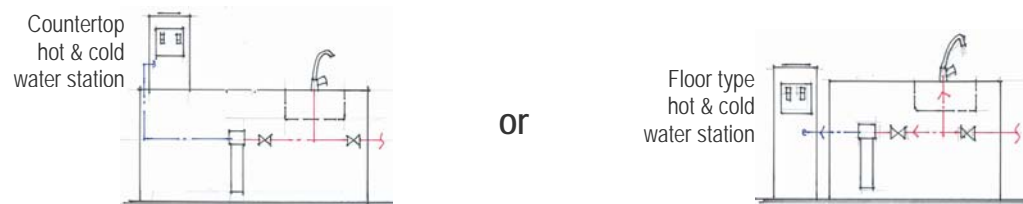

For an office with or a pantry catering for **20-50 people**,
1 unit of hot & cold water station and 1 unit of water boiler with 3M BEV130 should be used.

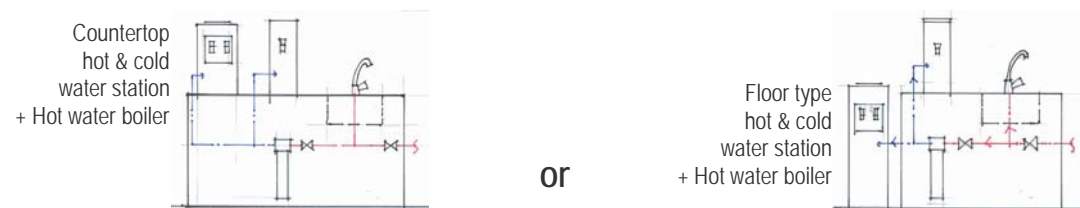

Applications

For Restaurant

There are **3 areas** inside the restaurant kitchen, **including preparation table, beverage counter and ice maker**, that are recommended to use filtered water when preparing drinks and foods in order to avoid unpleasant odor from using tap water. An individual filtration system for each area should be applied. *(Please refer to the specification of each filtration system for matching with different kinds of kitchen equipment.)*

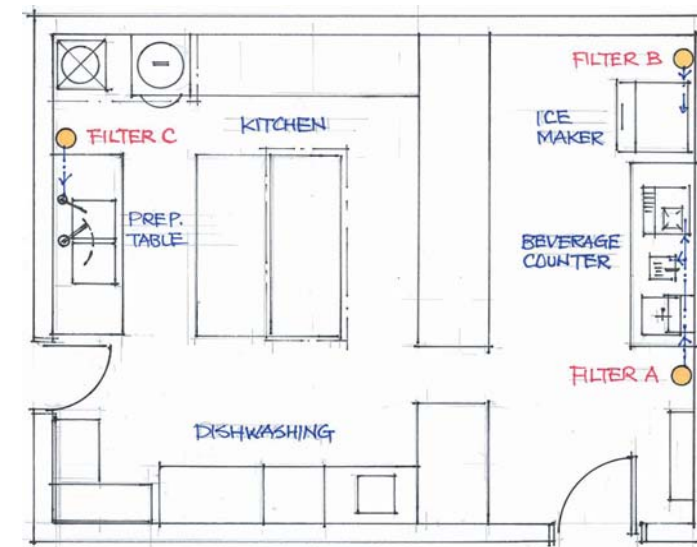

Typical water filtration system installation in kitchen

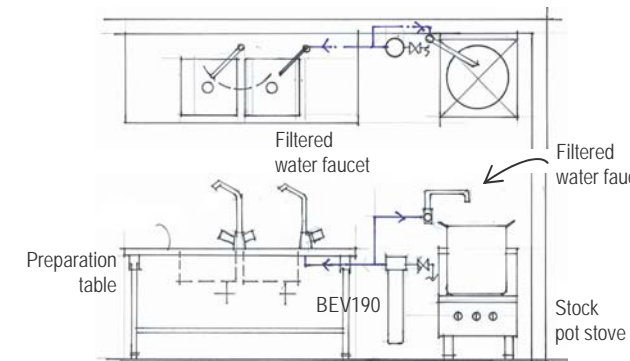

Filter C - BEV190
Preparation Area
(including salad veggie washing, soup making and rice cooking)



Filter B - BEV130
For Ice Maker



Filter A - BEV190
Beverage Counter
(including water boiler, drinking water dispenser and coffee machine)

Related Product

*With just a touch of the button,
you can enjoy quality drinking water anytime you want!*

We often find an unpleasant taste in the drinking water served in the restaurants or provided in your office pantry, especially when it is hot. Therefore, quality filtered water should be used in all the beverage equipment, such as ice machine, coffee machine and water boiler, in order to get the clean and refreshing water to prepare quality drinks.

Water boilers are mostly used in catering industry and in office pantry. With the help of a superior quality water filtration system, you can rest assured that the odor and harmful contaminants in water can be eliminated, giving you great tasting hot beverages.

Lincat – FilterFlow Water Boiler

Manufactured to the highest standards, Lincat’s FilterFlow Water Boiler combines style, function, reliability and value for money with a pioneering new development in water boiler filtration, i.e. incorporating a filter cartridge inside the boiler that ensures the water is always of the highest quality.



InSinkErator Instant Hot Water Dispenser

It is truly wonderful if near-boiling water can be provided instantly in the kitchen to prepare foods, wash utensils and make hot drinks etc. With InSinkErator’s Instant Hot Water Dispenser, it saves time and adds elegance to the kitchen.

Its Indulge Contemporary model is the finest line of instant hot water dispensers with stainless steel tanks for near-boiling 93.3°C (200°F) filtered water. The contemporary design, in an array of beautiful designer finishes, will complement any kitchen.



FAQ

About 3MTM Water Filtration System

Q: What is the filter media made of in the 3M filter cartridge?

A: 3M uses its patented technology to develop graded density and multi-composite carbon block as the core material for the filter cartridge. By the principle of carbon atom bonding, pollutants and impurities can be removed while ions like magnesium and potassium that are essential for human body can be retained as they will not bond with carbon atom.

Q: Water filters in the market mainly use activated carbon as filter media. What is the difference between 3M’s and other brands’ water filters?

A: While many filtration systems in the market claim that they are using activated carbon as filter media, the efficiency varies depending on the source of activated carbon, manufacturing method, density, granule size and adsorption area etc.

With 100 years’ patented filtration technology, 3M’s water filtration products have been granted certification by many international standard organization. Its activated carbon has been certified by the Food and Drug Administration (FDA) in the USA. The density and amount of activated carbon used in 3M water filter are many more than those of the other brands in the market. The greater the number of activated carbon, the greater the density and surface area for pollutant adsorption. Therefore, its performance is much better.

When you decide to buy a quality water filtration product, it is important that you choose a brand which is internationally renowned for its superior quality.

Cross section of 3M filter cartridge

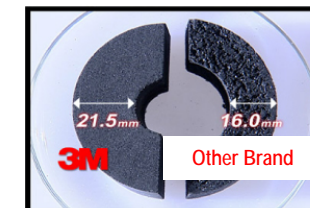
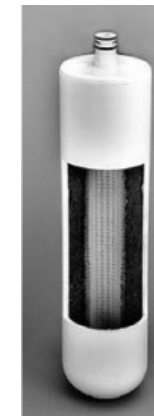

Comparison between 3M water filter and other filters

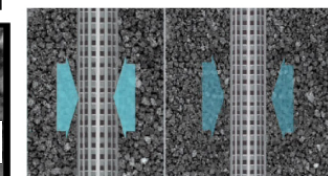
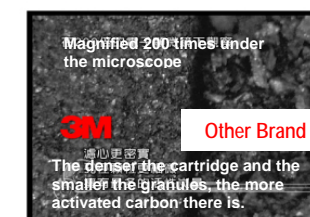

The more the activated carbon and the smaller its granules, the bigger the absorption area and the better in performance

Q: How often should the filter cartridge be replaced?

A: The average life span of the filter cartridge is 6-9 months and a maximum to 12 months. However, the performance may vary depending on the water usage and quality. The cartridge should be replaced once the flow of water slows down to ensure the best performance.

FAQ

Q: What should I do if the water flow does not slow down at the time when the filter cartridge should be replaced?

A: It is still recommended to replace it. It is because the life span of the filter cartridge is based on the efficiency of the removal of insoluble impurities and chemicals adsorption. If it is not replaced as per the suggested timeline, it may not reach its claimed performance.

Q: Can 3M filter cartridges be washed?

A: The design of the 3M filter cartridge is fully enclosed to avoid cross contamination of the filter media and ensure its efficiency. Also, every single filter cartridge is manufactured by 3M in the USA so that the quality is guaranteed. Instead of washing the filter cartridge, you only need to replace the entire cartridge with a new set.

Q: Is it easy to replace the filter cartridge?

A: 3M has two patented designs for replacing the filter cartridge:

(i) Sanitary Quick Change (SQC) for fast and easy cartridge replacement.



(ii) Built-in Bypass Valve enables the change of the cartridge without closing the water valve. *(Only suitable for model AP DWS-2500T and AP Easy series)*

Also, the filter head is designed to fit the original 3M filter cartridge only to ensure the product quality.

FAQ

Q: How do I know whether or not 3M water filtration systems will be as safe and effective as claimed in reducing various contaminants from water?

A: All the 3M home use water filtration systems have been tested and certified by NSF/ANSI Standard 42 and Standard 53.



NSF (National Sanitation Foundation) is committed to protect the public safety and environment. It is an independent, non-profit organization that develops standards and certifies products for the world's food, water and consumer goods. The standard of NSF is being adopted by the American National Standards Institute (ANSI) and recognized worldwide.

For drinking water treatment units, NSF has developed key standards for evaluation and certification, like the safety of the material used for filter media, the integrity of the product and the correctness of the product information provided etc. The standards include:

NSF/ANSI Standard 42: Aesthetic Effects

It applies to drinking water treatment units designed to reduce aesthetic contaminants, like chlorine, taste and odor and particulates that may be present in public or private drinking water.

NSF/ANSI Standard 53: Health Effects

It applies to drinking water treatment units designed to reduce specific health-related contaminants, such as lead, volatile organic chemicals (VOCs), MTBE (methyl tertiary-butyl ether) and cysts etc that may be present in public or private drinking water.

Products that meet these standards bear the NSF Mark (it does not apply to model: AP DWS-2500T as certification is still in process). Every set of 3M home use water filtration product includes the Performance Data Sheet. To look for the NSF listing, please visit this website www.nsf.com for details.

Q: Other than NSF certifications, did 3M water filtration products obtain any other certifications?

A: Other than obtaining the NSF/ANSI Standard 42 and Standard 53, 3M water filtration products have also obtained the following certifications:-



Food and Drug Administration (FDA)

The material used in 3M's filter media complies with the FDA CFR-21 standard.

Q: Can hot water be filtered using 3M water filtration system?

A: Since high temperature can damage the activated carbon of the filter cartridge and thus affects its efficiency, please **do not** use 3M water filtration system to filter hot water. The suggested operation temperature should be within 4.4 - 37.8°C.

FAQ

Q: Can you tell me the reason why the price of 3M filter cartridge is relatively higher than that of other water filters?

A: Every single 3M filter cartridge is produced by 3M's manufacture plant in the USA. To ensure the efficiency of each filter, the products have to be tested by NSF and labeled with the NSF mark before being released into the market. Moreover, the fully enclosed filter cartridge design and Sanitary Quick Change (SQC) feature make replacement of cartridge extremely easy. Therefore, the price is certainly worth it.

Q: Does the warranty cover filter cartridge?

A: No, the warranty does not cover filter cartridge. It is because when the filter cartridge is used, it cannot be verified if the input water is potable tap water or not. Besides, filter cartridges are consumable goods and its life span depends on the water usage and quality.

Differences between 3M water filtration system and other filtration methods

Q: What is ionized water?

A: Ionized water is formed when water charged with electricity and water molecules are discharged into ions. By using membrane or salt bridge, the exchange of ions is blocked, causing the change in the pH value of water. Meanwhile, it leads to the change in redox electric potential and dissociation constant, and thus acidic or alkaline water will be formed. There are popular notions asserting that acidic ionized water has disinfection function while alkaline ionized water can neutralize the acidic toxins in the body and remove carcinogenic free radicals. Also, it is claimed that ionized water can treat chronic diseases etc.

Actually, when alkaline ionized water reaches our stomach, it will be neutralized by the strong acidic gastric juice. Also, the healing function of ionized water has not yet been proven. In fact, you should be extremely careful about the use of water-ionizers machine. Underground water, spring water, mineral water or polluted water cannot be used as input water into the machine. It is because after ionization, water with heavy metals such as cadmium, lead and copper will become 'concentrated heavy metal liquid' which is toxic to human.

Q: What is Reverse Osmosis (RO) filtration?

A: Reverse Osmosis (RO) uses TFC membrane to separate the contaminants from water. The size of the membrane is 0.0001 micron. When water is pressed through the membrane, it can remove most of the bacteria, viruses and other harmful contaminants in water. The water treated by RO will become high purity water. Any substances and harmful contaminants that cannot pass through the membrane will be discharged as waste water.

FAQ

Since the water treated by RO will become high purity water, i.e. minerals like zincs, copper, calcium and irons etc, that are good to our health will also be discharged. Prolonged consumption of purity water may affect our health. Also, the membrane used for filtration is easily damaged by chlorine. Water in Hong Kong contains a lot of chlorine for disinfection during water treatment. Over time, it cannot be confirmed if the membrane is still intact, thus casting doubt on effectiveness.

Also, the operation of RO system requires the infusion of a great amount of water but it can only filter out a relatively small of water for use. The wastage can be as much as 75-85% of incoming water, depending on external environmental factors, like temperature.

Q: Will there be any changes in the pH value with the use of 3M water filtration system?

A: No. There will not be any major change in the pH value of the water treated by 3M water filtration system.

Q: There are 6 filter cartridges used in the filtration system of other brands, while only 1 or 2 in 3M water filtration systems. Can you tell me why?

A: With its patented technology, 3M has managed to combine filter cartridges of different functions into one, leading to a more-closely-packed filter cartridge and tinier granules. Through layers of filtration, impurities can be effectively removed while minerals which are essential to human body can be retained.

Also, the installation space required for 3M water filtration system is relatively small.

With the poly-filter-cartridge of 3M water filtration system, you do not need to change filter cartridges with different expiry dates at different times, or worse, get a technician to help you replace the cartridges. 3M allows you to save cost and time in comparison to using other filtration systems with multi filter cartridges.

3M Water Filtration System – Others

Q: Can the water treated by 3M water filtration system be drunk directly? What can I use the filtered water for?

A: Definitely. The 3M water filtration system is a direct drinking water system. The filtered water can be used for:

- (i) Direct drinking;
- (ii) Washing vegetables or fruits for salad;
- (iii) Making coffee and tea etc after boiling;
- (iv) Cooking soup and rice.

FAQ

Q: The material used in the filter cartridge of 3M water filtration system is PP. Can PP withstand high water pressure?

A: The maximum pressure that the PP can withstand is 375 psi, according to NSF's test, while the optimum operating water pressure is 25-125 psi. Therefore, it should work well with the regular household water pressure. In order to lower the risk of bursting the filter cartridges, our technician will check on-site if the water pressure is over 70 psi during installation. If it is above that level, a pressure-reducing valve will be added to regulate the water pressure.



3M Authorized Distributor of Water Filtration Systems in HK:
Total Nutrition Center Ltd.
Tel: (852) 2881-8270 Email: enquiry@tnc.com.hk
Website: www.tnc.com.hk